

The brand name "ESLON" in a bold, blue, sans-serif font, centered on the page.

ESLON

The main title of the manual, "SCH80 PVC & CPVC Piping Systems Specifications & Engineering Manual", in a bold, black, sans-serif font, centered on the page.

**SCH80 PVC & CPVC Piping Systems
Specifications & Engineering Manual**



Best Quality from Sekisui to the World

Sekisui Chemical is the leading company of plastic pipes in the world.

The brand of our plastic pipe is “Eslon”, which is well-known as high quality all over the world. Since 1953, Eslon pipe was first on the market, Sekisui Chemical has been providing a variety of plastic pipes.

Sekisui Chemical is the unique company in the various fields, who has the techniques of materials such as PVC polymerization, formulation, and CPVC denaturation of PVC resin, and the techniques of production, special long term evaluation, piping design and installation.

Our excellent technique has a high reputation not only in Japan, but also in the world.

Sekisui Chemical is proud of providing Schedule80 PVC & CPVC pipes and fittings for the world based on the best quality.

TABLE OF CONTENTS

1. Advantages of Eslon Sch80 PVC and CPVC Pipe	4
2. Eslon Sch80 PVC and CPVC Pipe and Fittings	8
1 Physical Properties of PVC and CPVC Material	9
2 Schedule80 Pipe	11
3 Schedule80 Fittings	12
4 True Union	26
5 Flange	27
6 Gasket	30
3. Installation	32
1 Storage and Handling	33
2 General Recommendations	35
3 Rules and Guidelines	36
4. Safety Precautions	44

NOTE:

Some of the information contained herein is generated by independent sources. Such information is accurate to the best of SEKISUI's knowledge, but SEKISUI disclaims any liability for the accuracy or completeness of such information or the reliance by any party on such information.

ESLON QUALITY POLICY

It is the policy of all operations of Eslon to continuously strive to meet the requirements of our customers by offering products and services which are of the highest quality. This requires that we obtain thorough leadership in quality of product, quality of service, and quality of delivery, by providing a work environment which nurtures the growth and involvement of all employees. We will maintain the most effective quality system to enable us to best meet our customers' needs.

Understanding Safety Alert Messages

There are several types of safety-alert messages which appear throughout this Technical Manual. Familiarize yourself with these types of messages and the importance of the various signal words, as explained below.



This safety alert symbol indicates important safety messages in this manual.

When you see this symbol be alert to the possibility of personal injury and carefully read and fully understand the message that follows.



DANGER: Indicates an imminently hazardous situation which, if not avoided, will result in death or serious injury. Safety Signs identified by the signal word DANGER should be used sparingly and only for those situations presenting the most serious hazards.



WARNING: Indicates a potentially hazardous situation which, if not avoided, will result in death or serious injury. Hazards identified by the signal word WARNING present a lesser degree of risk of injury or death than those identified by the signal word DANGER.



CAUTION: Indicates a potentially hazardous situation which, if not avoided, may result in minor or moderate injury.

1

Advantages of Eslon Sch80 PVC and CPVC Pipe

Advantages of Eslon Sch80 PVC and CPVC Pipe

Sekisui Eslon PVC and CPVC pipe have a number of outstanding features, such as high chemical resistance, easy installation, and reasonable price, which can lead to the reduction of total construction cost. Eslon PVC and CPVC can or should replace other materials of construction in size ranges available for all sorts of piping systems.

CPVC (Chlorinated Polyvinyl Chloride) is another rigid pipe which has three highly-desirable characteristics, good mechanical strength at high temperatures and higher chemical resistance and relatively compared to metal. CPVC polymer is more chlorinated into PVC polymer. This extra chlorine is responsible for the material's high-temperature strength and other properties which are valuable for industrial piping. For pressure piping

applications, it is recommended for temperatures as high as 200°F compared with 140°F of PVC.

Eslon Sch80 PVC & CPVC Pipe ranging in sizes from 1/2" through 24", and PVC fittings and PVC valves are available for light, medium, and heavy duty use.

PVC and CPVC are environmentally friendly polymer in terms of low carbonic acid gas emission in manufacturing process

Advantages

Chemical Resistance

PVC and CPVC pipe are inert to attack by strong acids, alkalis, salt solutions, alcohols, and many other chemicals. They are dependable on corrosive applications and impart no tastes or odors to materials carried in them. They do not react with materials carried, nor act as a catalyst. All possibility of contamination, or chemical process changes, and all danger of clouding, slugging, or discoloration are eliminated.

Strength

PVC and CPVC pipe are highly resilient, tough and durable products that have high tensile and high impact strength. They will withstand surpris-

ingly high pressure for long periods.

Fire Resistance PVC and CPVC pipe products are self extinguishing and will not support combustion. They have an ASTM E-84 flame spread rate of 25 or less.

Internal Corrosion Resistance

PVC and CPVC pipe resist chemical attack by most acids, alkalis, salts, and organic media such as alcohols and aliphatic hydrocarbons, within certain limits of temperature and pressure. They provide the needed chemical resistance, while eliminating the disadvantages of special metals, lined piping, glass, wood, ceramics, or other special corrosion-resisting materials, which formerly had to be used.

External Corrosion Resistance

Industrial fumes, humidity, saltwater, weather, atmospheric, or underground conditions, regardless of type of soil or moisture encountered, cannot harm rigid PVC and CPVC plastic pipe.

Scratches or surface abrasions do not provide points which corrosive elements can attack.

Immunity to Galvanic or Electrolytic Attack PVC and CPVC pipe are inherently immune to galvanic or electrolytic action. They can be used underground, underwater, in the presence of metals, and can also be connected to metals.

Freedom from Toxicity, Odors, Tastes

PVC and CPVC piping are non-toxic, odorless, and tasteless. They have been listed by the National Sanitation Foundation for use with potable water.

Corrosion Free

With many other pipe materials, slight corrosion may occur. The corroded particles can contaminate the piped fluid, complicating further processing, or causing bad taste, odors, or discoloration. This is particularly undesirable when the piped fluid is for domestic consumption. With PVC and CPVC, there are no corrosive by-products, therefore, no contamination of the piped fluid.

Low Friction Loss

The smooth interior surfaces of PVC and CPVC pipe, compared to metal and other piping materials, assure low friction loss and high flow rates. Additionally, since PVC and CPVC pipe will not rust, pit, scale, or corrode, the high flow rates will be maintained for the life of the piping system.

Low Thermal Conductivity

PVC and CPVC pipe have a much lower thermal conductivity factor than metal pipe. Therefore, fluids being piped maintain a more constant temperature. In most cases, pipe insulation is not required.

Easy Installation and Low Installation Cost

PVC and CPVC pipe are lightweight, convenient to handle, relatively flexible, and easy to install. For example, it is approximately 1/5 to 1/6 for the weight of metal.

They have smooth, seamless interior walls. No special tools are required for cutting. They can be installed using solvent cementing, threading, flanging techniques.

These features lead to lower installed costs than conventional metal piping.

Maintenance Free

Once a PVC or CPVC piping system is properly selected, designed, and installed, it is virtually maintenance free. It will not rust, scale, pit, corrode, or promote build-up on the interior. Therefore, years of trouble-free service can be expected when using Eslon PVC and CPVC pipe.

Standard Approved

Sekisui Eslon PVC and CPVC pipe complies with the industry standards and requirements as set forth by the American Society for Testing and Materials (ASTM) and the National Sanitation Foundation (NSF International).



Eslon Sch80 PVC & CPVC Piping System

2

Eslon Sch80 PVC and CPVC Pipe and Fittings

1 Physical Properties of PVC and CPVC Material.....	9
2 Schedule80 Pipe	11
3 Schedule80 Fittings	12
4 True Union.....	26
5 Flange.....	27
6 Gasket.....	30

1

Physical Properties of PVC and CPVC Material

Properties of PVC & CPVC PIPE

ITEM	Test Method	SI unit		
		unit	PVC	CPVC
GENERAL				
Cell Classification	ASTM D1784	—	12454	23447
Maximum Usable Temp.	—	°C	60	93
Specific Gravity @ 73°F(23°C)	ASTM D792	g/cc	1.42±0.02	1.55±0.02
Water Absorption % increase 24 hrs@ 73°F(23°C)	ASTM D570	%	0.04	0.04
Hardness, Rockwell	ASTM D785	—	110 - 120	115-125
Poisson's Ratio @ 73°F(23°C)	ASTM D638	—	0.38	0.36
MECHANICAL				
Tensile Strength @ 73°F(23°C)	ASTM D638	MPa	49.9	53.1
Tensile Strength @194 °F(90°C)	"	MPa	—	22.1
Tensile Modulus of Elasticity @ 73°F(23°C)	"	GPa	2.83	2.62
Tensile Modulus of Elasticity @ 194°F(90°C)	"	GPa	—	1.52
Flexural Strength @ 73°F(23°C)	ASTM D790	MPa	96.5	89.6
Flexural Modulus of Elasticity @ 73°F(23°C)	"	GPa	2.76	2.69
Compressive Strength @ 73°F(23°C) $\epsilon = 10\%$	ASTM D695	MPa	69.0	96.5
Compressive Modulus of Elasticity @ 73°F(23°C)	"	GPa	0.76	1.00
Izod Impact, notched @ 73°F(23°C)	ASTM D256	J/m	80	160
THERMAL				
Coefficient of Linear Expansion	ASTM D696	m/m/°C	6.0-8.0x10 ⁻⁵	7.0-8.0x10 ⁻⁵
Coefficient of Thermal Conductivity	ASTM C177	Watt/m/°K	0.17	0.13
Heat Deflection Temperature Under Load (264psi, annealed)	ASTM D648	°C	74	110
Specific Heat	ASTM D2766	J/°K/g	1.1	1.1
ELECTRICAL				
Volume Resistivity	ASTM D257	ohm/cm	>1.0 x 10 ¹⁵	>1.0 x 10 ¹⁵
Dielectric Strength	ASTM D149	volt/mm	>1000	>1000
Dielectric Constant	ASTM D150	—	3	3
Power Factor	"	—	0.01-0.02	0.01-0.02
Electrical Conductivity	—	—	Non Conductor	Non Conductor
FIRE PERFORMANCE				
Flammability Rating	UL-94	—	V-0	V-0, 5VB, 5VA
Flame Spread Index	"	—	<10	<10
Average Time of Burning	ASTM D635	sec	<5	<5
Average Extent of Burning	"	mm	<10	<10
Burning Rate	"	mm/min	Self Extinguishing	Self Extinguishing
Limiting Oxygen Index (LOI)	ASTM D2863	LOI	45	60

Properties of PVC & CPVC PIPE Fitting

ITEM	Test Method	SI unit		
		unit	PVC	CPVC
GENERAL				
Cell Classification	ASTM D1784		12454	23447
Maximum Usable Temp.		°C	60	93
Specific Gravity @ 73°F (23°C)	ASTM D792	g/cc	1.42±0.02	1.55±0.02
Water Absorption % increase 24 hrs@ 73°F (23°C)	ASTM D570	%	0.04	0.04
Hardness, Rockwell	ASTM D785		110 - 120	115-125
Poisson's Ratio @ 73°F (23°C)	ASTM D638		0.38	0.36
MECHANICAL				
Tensile Strength @ 73°F (23°C)	ASTM D638	MPa	49.9	51.0
Tensile Strength @194 °F (90°C)		MPa		20.7
Tensile Modulus of Elasticity @ 73°F (23°C)		GPa	2.90	2.62
Tensile Modulus of Elasticity @ 194°F (90°C)		GPa		1.38
Flexural Strength @ 73°F (23°C)	ASTM D790	MPa	89.6	82.7
Flexural Modulus of Elasticity @ 73°F (23°C)		GPa	2.90	2.76
Compressive Strength @ 73°F (23°C) $\epsilon = 10\%$	ASTM D695	MPa	69.0	103.4
Compressive Modulus of Elasticity @ 73°F(23°C)		GPa	0.76	1.10
Izod Impact, notched @ 73°F (23°C)	ASTM D256	J/m	66	162
THERMAL				
Coefficient of Linear Expansion	ASTM D696	m/m/°C	6.0-8.0x10 ⁻⁵	7.0-8.0x10 ⁻⁵
Coefficient of Thermal Conductivity	ASTM C177	Watt/m/°K	0.16	0.13
Heat Deflection Temperature Under Load (264psi, annealed)	ASTM D648	°C	80	102
Specific Heat	ASTM D2766	J/°K/g	1.1	1.1
ELECTRICAL				
Volume Resistivity	ASTM D257	ohm/cm	>1.0 x 10 ¹⁵	>1.0 x 10 ¹⁵
Dielectric Strength	ASTM D149	volt/mm	>1000	>1000
Dielectric Constant	ASTM D150		3	3
Power Factor	"		0.01-0.02	0.01-0.02
Electrical Conductivity			Non Conductor	Non Conductor
FIRE PERFORMANCE				
Flammability Rating	UL-94		V-0	V-0, 5VB, 5VA
Flame Spread Index	"		<10	<10
Average Time of Burning	ASTM D635	sec	<5	<5
Average Extent of Burning		mm	<10	<10
Burning Rate		mm/min	Self Extinguishing	Self Extinguishing
Limiting Oxygen Index (LOI)	ASTM D2863	LOI	45	60

2 Schedule 80 Pipe

Eslon Pipe is Manufactured to The Following Standard Specifications

Type	Material (Cell Classification)	Dimensions	Commercial Classification
PVC Schedule 80	ASTM D-1784 (12454)	ASTM D-1785	Type I ,Grade 1, PVC 1120
CPVC Schedule 80	ASTM D-1784 (23447)	ASTM F-441	Type IV ,Grade 1, CPVC 4120

*ASTM F480 Well Casing

Eslon pipe and fittings are approved by NSF International 14 and 61.

NSF standard 14 : Plastics Piping System Components and Related Materials

NSF standard 61 : Drinking Water System Components - Health Effects

Schedule 80 PVC and CPVC Pipe Dimensions, Weights and Maximum Operating Pressure



Nominal Pipe Size		Outside Diameter		Wall Thickness		Approx. Inside Diameter	Nominal Weight		Max. operating Pressure
inch	mm	mm		mm			PVC	CPVC	
							kg/m	kg/m	MPa
1/2"	15	21.34	±0.10	3.73	+0.51	13.4	0.31	0.34	5.86
3/4"	20	26.67	±0.10	3.91	+0.51	18.3	0.42	0.46	4.76
1"	25	33.40	±0.13	4.55	+0.53	23.8	0.62	0.67	4.34
1-1/4"	32	42.16	±0.13	4.85	+0.58	31.9	0.86	0.93	3.59
1-1/2"	40	48.26	±0.15	5.08	+0.61	37.5	1.04	1.12	3.24
2"	50	60.32	±0.15	5.54	+0.66	48.6	1.44	1.56	2.76
2-1/2"	65	73.02	±0.18	7.01	+0.84	58.2	2.19	2.37	2.90
3"	80	88.90	±0.20	7.62	+0.91	72.8	2.93	3.18	2.55
4"	100	114.30	±0.23	8.56	+1.02	96.2	4.29	4.65	2.21
5"	125	141.30	±0.25	9.53	+1.14	121.1	5.95	6.45	2.00
6"	150	168.28	±0.28	10.97	+1.32	145.0	8.19	8.87	1.93
8"	200	219.08	±0.38	12.70	+1.52	192.2	12.43	13.48	1.72
10"	250	273.05	±0.38	15.06	+1.80	241.1	18.44	19.98	1.59
12"	300	323.85	±0.38	17.45	+2.08	286.9	25.37	27.49	1.59
14"	350	355.60	±0.38	19.05	+2.29	315.2	30.43	32.98	1.52
16"	400	406.40	±0.48	21.41	+2.57	361.0	39.13	42.41	1.52
18"	450	457.20	±0.48	23.80	+2.84	406.8	48.94	53.05	1.52
20"	500	508.00	±0.58	26.19	+3.15	452.5	59.90	64.92	1.52
24"	600	609.60	±0.79	30.94	+3.71	544.0	84.97	92.11	1.45

NOTE: Maximum Operating Pressure is applied to 23°C

3 Schedule 80 Fittings

Eslon Thermoplastic Fittings are manufactured to The Following Standard Specifications

Type	Material (Cell Classification)	Dimensions	Commercial Classification
PVC Schedule 80	ASTM D-1784 (12454)	ASTM D-2467	Type I ,Grade 1, PVC 1120
		ASTM D-2464	
CPVC Schedule 80	ASTM D-1784 (23447)	ASTM F-439	Type IV ,Grade 1, CPVC 4120
		ASTM F-437	

Eslon pipe and fittings are approved by NSF International 14 and 61.

NSF standard 14 : Plastics Piping System Components and Related Materials

NSF standard 61 : Drinking Water System Components - Health Effects

Socket Dimensions

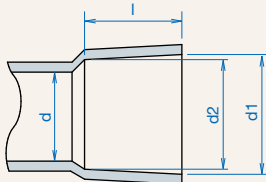
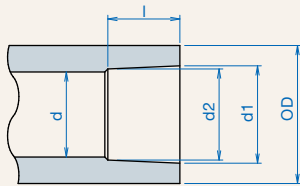

PVC AND CPVC SCHEDULE 80 TAPER SOCKET DIMENSIONS (SOLVENT CEMENT STYLE)
ASTM D-2467 (PVC) F-439 (CPVC)

Nomi-nal Pipe Size	OD mm	Inside Diameter min d mm	Socket Entrance Diameter d1 mm	Socket Bottom Diameter d2 mm	Socket Length min l mm
1/2"	30	18	21.54 ±0.10	21.23 ±0.10	22.22
3/4"	35	24	26.87 ±0.10	26.57 ±0.10	25.40
1"	43	30	33.65 ±0.13	33.27 ±0.13	28.58
1-1/4"	53	37	42.42 ±0.13	42.04 ±0.13	31.75
1-1/2"	60	45	48.56 ±0.15	48.11 ±0.15	34.93
2"	73	57	60.63 ±0.15	60.17 ±0.15	38.10
2-1/2"	88	69	73.38 ±0.18	72.85 ±0.18	44.45
3"	107	85	89.31 ±0.20	88.70 ±0.20	47.63
4"	133	109	114.76 ±0.23	114.10 ±0.23	57.15
5"	162	132	141.81 ±0.25	141.00 ±0.25	68.00
6"	192	156	168.83 ±0.28	168.00 ±0.28	76.00
8"	247	202	219.84 ±0.38	218.70 ±0.38	103.00
10"	307	265	273.81 ±0.38	272.67 ±0.38	140.00
12"	363	315	324.61 ±0.38	323.47 ±0.38	155.00
14"	394	346	356.49 ±0.38	355.22 ±0.38	226.60
16"	451	396	407.54 ±0.38	405.89 ±0.38	254.00
18"	-	407	458.60 ±0.51	456.69 ±0.51	304.80
20"	-	453	509.65 ±0.64	507.49 ±0.64	304.80
24"	-	544	611.51 ±0.46	608.84 ±0.46	304.80

3 Schedule 80 Fittings

Thread Dimensions

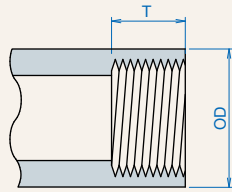

FEMALE TAPER THREADS
ASTM D-2464 (PVC) F-437 (CPVC)
ASTM F-1496

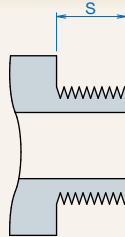

MALE TAPER THREADS
ASTM D-2464 (PVC) F-437 (CPVC)
ASTM F-1496

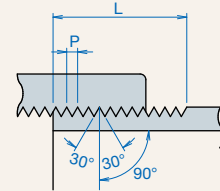

**AMERICAN NATIONAL STANDARD
TAPER PIPE THREADS (NPT)**
ASME (ANSI) B1.20.1
ASTM F-1498

Nominal Pipe Size	Pipe	Female Thread Min. Length	Male Thread Min. Length	Overall Pipe Thread Length	Threads Per In.	Pitch of Thread	Height of Thread
	OD mm	T mm	S mm	L mm	N per inch	P mm	h mm
1/2"	32.5	16.26	13.46	19.85	14.0	1.814	1.451
3/4"	38.2	16.51	13.92	20.15	14.0	1.814	1.451
1"	46.0	20.57	17.27	25.01	11.5	2.209	1.767
1-1/4"	56.0	21.59	18.03	25.62	11.5	2.209	1.767
1-1/2"	63.5	21.59	18.29	26.04	11.5	2.209	1.767
2"	77.0	22.86	19.30	26.88	11.5	2.209	1.767
2-1/2"	91.0	30.25	28.96	39.91	8.0	3.175	2.540
3"	107.0	33.02	30.48	41.50	8.0	3.175	2.540
4"	138.0	35.05	33.02	44.04	8.0	3.175	2.540

Coupling

Coupling S X S

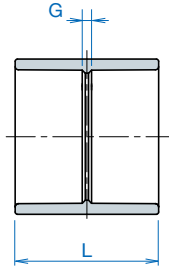

Size	mm		Weight (kg/pc)	
	L	G	PVC	CPVC
1/2"	50	5.6	0.024	0.026
3/4"	56	5.2	0.031	0.034
1"	63	5.8	0.045	0.049
1-1/4"	69	5.5	0.080	0.087
1-1/2"	75	5.1	0.110	0.120
2"	85	8.8	0.160	0.175
2-1/2"	96	7.1	0.255	0.278
3"	102	6.7	0.384	0.419
4"	123	8.7	0.553	0.604
5"	144	8.0	0.860	0.939
6"	165	10.0	1.372	1.498
8"	216	10.0	3.075	3.300
10"	295	15.0	6.170	6.340
12"	330	20.0	9.195	9.680
14"	480	19.4	14.595	16.240
16"	538	28.0	21.590	24.190

Coupling FT X FT

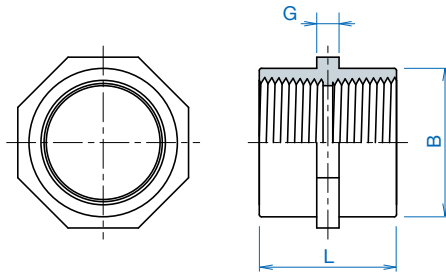

Size	mm			Weight (kg/pc)	
	L	G	B	PVC	CPVC
1/2"	39.0	5.0	32.5	0.028	0.029
3/4"	39.0	5.0	38.1	0.036	0.037
1"	47.0	6.0	46.0	0.059	0.062
1-1/4"	55.0	6.0	56.0	0.092	0.097
1-1/2"	55.0	7.0	63.5	0.116	0.121
2"	60.5	9.5	77.0	0.166	0.175
2-1/2"	87.0	10.0	91.0	0.325	0.341
3"	90.0	12.0	107.0	0.412	0.433
4"	96.0	13.0	138.0	0.708	0.743

3 Schedule 80 Fittings

Reducing Coupling

Reducing Coupling
S X S

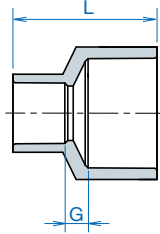

Size	mm		Weight (kg/pc)	
	L	G	PVC	CPVC
3/4" x 1/2"	53.5	5.9	0.026	0.029
1" x 1/2"	60.0	9.2	0.042	0.046
1" x 3/4"	60.0	6.0	0.040	0.044
1-1/4" x 1/2"	68.0	14.0	0.063	0.069
1-1/4" x 3/4"	68.0	10.9	0.061	0.066
1-1/4" x 1"	68.0	7.7	0.070	0.076
1-1/2" x 1/2"	75.0	17.9	0.083	0.090
1-1/2" x 3/4"	75.0	14.7	0.080	0.088
1-1/2" x 1"	75.0	11.5	0.089	0.098
1-1/2" x 1-1/4"	75.0	8.3	0.099	0.108
2" x 1/2"	83.0	22.7	0.118	0.128
2" x 3/4"	83.0	19.5	0.115	0.125
2" x 1"	83.0	16.3	0.124	0.135
2" x 1-1/4"	83.0	13.2	0.134	0.146
2" x 1-1/2"	83.0	10.0	0.142	0.154
2-1/2" x 1-1/2"	93.0	13.6	0.205	0.224
2-1/2" x 2"	93.0	10.5	0.222	0.242
3" x 1"	106.0	29.8	0.317	0.346
3" x 1-1/2"	106.0	23.4	0.313	0.342
3" x 2"	106.0	20.3	0.443	0.483
3" x 2-1/2"	106.0	13.9	0.361	0.394

Size	mm		Weight (kg/pc)	
	L	G	PVC	CPVC
4" x 2"	125.0	29.8	0.509	0.556
4" x 2-1/2"	125.0	23.4	0.535	0.584
4" x 3"	125.0	20.2	0.597	0.652
5" x 4"	144.0	18.9	0.860	1.014
6" x 3"	168.0	41.9	1.508	1.646
6" x 4"	168.0	31.8	1.413	1.542
6" x 5"	168.0	21.2	1.494	1.631
8" x 4"	218.0	57.9	2.751	3.003
8" x 6"	220.0	39.0	2.956	3.227
10" x 8"	287.0	44.0	5.622	6.137
12" x 8"	331.7	76.7	8.218	8.971
12" x 10"	328.0	26.0	8.784	9.589
14" x 12"	425.1	40.0	13.060	16.300
16" x 12"	493.0	88.0	18.400	20.608
16" x 14"	543.2	62.6	25.800	28.900

Combination Table of Coupling

+ : Coupling without Bushing +B: with one Bushing +B*2: with 2 pieces of Bushing

		Reducing Size															
		1/2"	3/4"	1"	1-1/4"	1-1/2"	2"	2-1/2"	3"	4"	5"	6"	8"	10"	12"	14"	16"
Inlet Size	1/2"	+															
	3/4"	+	+														
	1"	+	+	+													
	1-1/4"	+	+	+	+												
	1-1/2"	+	+	+	+	+											
	2"	+	+	+	+	+	+										
	2-1/2"	+B	+B	+B	+B	+	+	+									
	3"	+B	+B	+	+B	+	+	+	+								
	4"	+B	+B	+B	+B	+B	+	+	+	+							
	5"	+B*2	+B*2	+B	+B	+B	+B	+B	+B	+	+						
	6"	+B*2	+B*2	+B	+B	+B	+B	+B	+B	+	+	+	+				
	8"	+B*2	+B*2	+B	+B	+B	+B	+B	+B	+	+B	+	+				
	10"			+B*2	+B*2	+B*2	+B*2	+B*2	+B*2	+B	+B*2	+B	+	+			
	12"			+B*2	+B*2	+B*2	+B*2	+B*2	+B*2	+B	+B*2	+B	+	+	+		
14"									+B*2	+B*2	+B*2	+B	+B	+B	+	+	
16"									+B*2	+B*2	+B*2	+B	+B	+B	+	+	+

90° Elbow

90° Elbow S X S

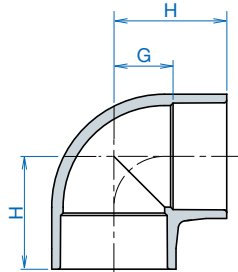

Size	mm		Weight (kg/pc)	
	G	H	PVC	CPVC
1/2"	15.3	37.5	0.037	0.040
3/4"	17.1	42.5	0.045	0.049
1"	21.4	50.0	0.080	0.087
1-1/4"	26.3	58.0	0.140	0.153
1-1/2"	30.1	65.0	0.185	0.202
2"	35.9	74.0	0.270	0.295
2-1/2"	44.6	89.0	0.464	0.506
3"	53.4	101.0	0.771	0.842
4"	63.9	121.0	1.240	1.354
5"	77.5	150.0	2.185	2.385
6"	93.2	173.0	3.530	3.853
8"	120.1	225.0	7.135	7.788
10"	150.0	290.0	12.585	12.700
12"	172.1	327.1	18.835	19.325
14"	197.0	426.6	26.100	28.290
16"	235.4	492.0	40.890	44.000

90° Elbow FT X FT

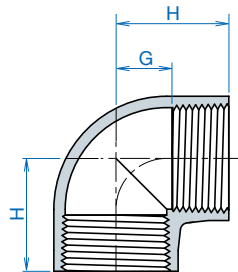

Size	mm		Weight (kg/pc)	
	G	H	PVC	CPVC
1/2"	15.0	33.0	0.047	0.054
3/4"	17.0	35.0	0.065	0.074
1"	22.0	43.0	0.100	0.132
1-1/4"	26.3	52.3	0.175	0.217
1-1/2"	30.0	56.0	0.234	0.314
2"	36.0	63.0	0.428	0.471
2-1/2"	44.5	84.5	0.716	0.788
3"	52.0	94.0	1.309	1.440
4"	63.5	108.0	2.165	2.363

90° Elbow S X FT

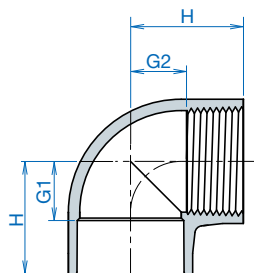

Size	mm			Weight (kg/pc)	
	G1	G2	H	PVC	CPVC
1/2"	15.3	19.5	37.5	0.037	0.040
3/4"	17.1	24.5	42.5	0.045	0.049
1"	21.4	28.0	50.0	0.080	0.087
1-1/4"	26.3	32.0	58.0	0.140	0.153
1-1/2"	30.1	39.0	65.0	0.185	0.202
2"	35.9	47.0	74.0	0.270	0.295
2-1/2"	44.6	49.0	89.0	0.464	0.506
3"	53.4	59.0	101.0	0.771	0.842
4"	63.9	76.6	121.0	1.240	1.354

3 Schedule 80 Fittings

45° Elbow

45° Elbow S X S

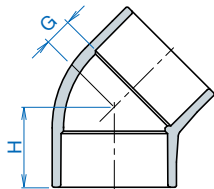

Size	mm		Weight (kg/pc)	
	G	H	PVC	CPVC
1/2"	7	29	0.030	0.033
3/4"	9	34	0.040	0.044
1"	8	37	0.064	0.070
1-1/4"	11	43	0.102	0.111
1-1/2"	12	47	0.130	0.142
2"	17	55	0.190	0.207
2-1/2"	20	64	0.359	0.392
3"	24	72	0.580	0.633
4"	29	86	0.915	0.999
5"	36	106	1.595	1.741
6"	41	120	2.580	2.816
8"	50	155	4.925	5.376
10"	60	207	9.375	9.960
12"	81	235	15.330	16.733
14"	101	329	21.100	23.180
16"	107	360	28.732	32.180

45° Elbow FT X FT

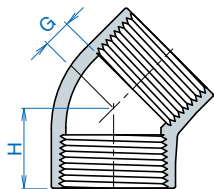

Size	mm		Weight (kg/pc)	
	G	H	PVC	CPVC
1/2"	6.8	24.8	0.040	0.044
3/4"	8.5	26.5	0.058	0.063
1"	9.5	31.5	0.094	0.103
1-1/4"	11.3	37.3	0.146	0.160
1-1/2"	12.1	38.1	0.200	0.218
2"	17.0	44.0	0.298	0.326
2-1/2"	19.5	64.0	0.537	0.591
3"	24.0	72.0	0.920	1.012
4"	28.5	86.0	1.503	1.640

45° Elbow S X FT

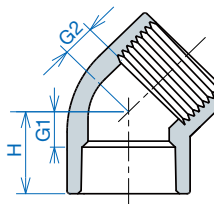

Size	mm			Weight (kg/pc)	
	G1	G2	H	PVC	CPVC
1/2"	6.8	8.5	24.0	0.030	0.033
3/4"	8.6	4.4	34.0	0.040	0.044
1"	8.4	10.4	37.0	0.064	0.070
1-1/4"	11.3	15.7	43.0	0.102	0.111
1-1/2"	12.1	16.5	47.0	0.130	0.142
2"	16.4	21.1	55.0	0.140	0.207
2-1/2"	14.6	33.8	64.0	0.354	0.342
3"	24.4	38.5	72.0	0.580	0.633
4"	28.9	50.5	86.0	0.415	0.444

Tee

Tee S X S X S

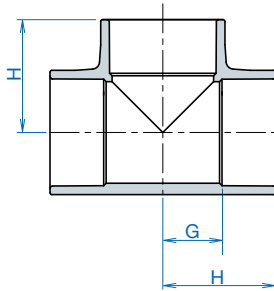

Size	mm		Weight (kg/pc)	
	G	H	PVC	CPVC
1/2"	15.3	37.5	0.050	0.055
3/4"	17.1	42.5	0.065	0.071
1"	21.4	50.0	0.105	0.115
1-1/4"	26.3	58.0	0.184	0.201
1-1/2"	30.1	65.0	0.235	0.257
2"	35.9	74.0	0.355	0.388
2-1/2"	44.6	89.0	0.619	0.676
3"	53.4	101.0	1.010	1.102
4"	63.9	121.0	1.581	1.726
5"	79.5	147.5	2.684	2.930
6"	94.6	173.0	4.325	4.721
8"	122.0	225.0	8.980	9.802
10"	150.0	290.0	15.250	16.646
12"	181.8	330.0	25.245	25.830
14"	197.8	426.6	35.885	38.800
16"	236.2	492.0	54.570	58.600

Tee FT X FT X FT

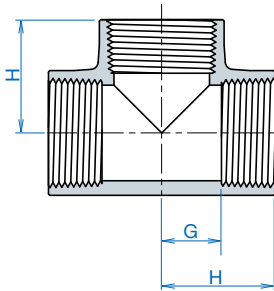

Size	mm		Weight (kg/pc)	
	G	H	PVC	CPVC
1/2"	16.7	33.0	0.066	0.072
3/4"	18.5	35.0	0.091	0.099
1"	22.4	43.0	0.150	0.164
1-1/4"	30.7	52.3	0.249	0.272
1-1/2"	34.4	56.0	0.334	0.365
2"	40.1	63.0	0.503	0.553
2-1/2"	58.8	89.0	0.866	0.946
3"	68.0	101.0	1.467	1.614
4"	86.0	121.0	2.336	2.550

Tee S X S X FT

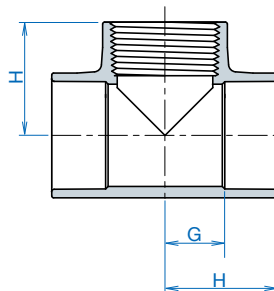

Size	mm		Weight (kg/pc)	
	G	H	PVC	CPVC
1/2"	15.3	37.5	0.050	0.055
3/4"	17.1	42.5	0.065	0.071
1"	21.4	50.0	0.105	0.115
1-1/4"	26.3	58.0	0.184	0.201
1-1/2"	30.1	65.0	0.235	0.257
2"	35.9	74.0	0.355	0.388
2-1/2"	44.6	89.0	0.619	0.676
3"	53.4	101.0	1.010	1.102
4"	63.9	121.0	1.581	1.726

3 Schedule 80 Fittings

Reducing Tee

Reducing Tee S X S X S

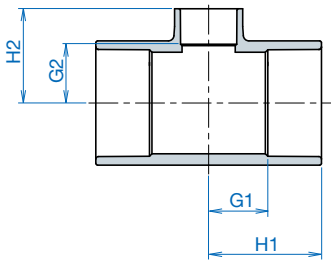

Size	mm				Weight (kg/pc)	
	G1	G2	H1	H2	PVC	CPVC
3/4" x 1/2"	17.1	17.5	42.5	40.0	0.060	0.067
1" x 1/2"	21.4	21.5	50.0	44.0	0.096	0.107
1" x 3/4"	21.4	21.5	50.0	46.0	0.098	0.109
1-1/4" x 1/2"	26.3	26.5	58.0	48.0	0.152	0.170
1-1/4" x 3/4"	26.3	26.5	58.0	52.0	0.154	0.172
1-1/4" x 1"	26.3	26.5	58.0	54.0	0.159	0.178
1-1/2" x 1/2"	30.1	30.0	65.0	52.0	0.200	0.223
1-1/2" x 3/4"	30.1	30.0	65.0	55.0	0.202	0.226
1-1/2" x 1"	30.1	30.0	65.0	58.0	0.207	0.231
1-1/2" x 1-1/4"	30.1	30.0	65.0	62.0	0.216	0.241
2" x 1/2"	35.9	36.5	74.0	58.0	0.281	0.314
2" x 3/4"	35.9	36.5	74.0	61.0	0.283	0.316
2" x 1"	35.9	36.5	74.0	66.0	0.292	0.326
2" x 1-1/4"	35.9	36.5	74.0	68.0	0.303	0.338
2" x 1-1/2"	35.9	36.5	74.0	71.0	0.312	0.349
2-1/2" x 1-1/2"	44.6	44.0	89.0	77.0	0.534	0.596
2-1/2" x 2"	44.6	44.0	89.0	82.0	0.552	0.617
3" x 1-1/2"	53.4	53.5	101.0	85.0	0.711	0.794
3" x 2"	53.4	53.5	101.0	90.0	0.733	0.819
3" x 2-1/2"	53.4	53.5	101.0	97.0	0.768	0.858
4" x 2"	63.9	66.5	121.0	101.0	1.328	1.483
4" x 2-1/2"	63.9	66.5	121.0	108.0	1.326	1.481
4" x 3"	63.9	66.5	121.0	115.5	1.380	1.541
5" x 4"	79.5	81.0	147.5	136.0	2.605	2.790
6" x 3"	94.8	96.0	173.0	143.0	3.980	4.240
6" x 4"	94.8	96.0	173.0	152.0	4.015	4.320
6" x 5"	94.6	96.0	173.0	165.0	4.180	4.510
8" x 3"	122.0	123.5	225.0	170.0	8.290	8.420
8" x 4"	122.0	123.5	225.0	180.0	8.190	8.550
8" x 6"	122.0	123.5	225.0	202.6	8.545	8.915
10" x 4"	150.0	153.5	290.0	210.0	13.435	14.285
10" x 8"	150.0	153.5	290.0	261.0	14.645	15.440
12" x 4"	175.0	181.5	330.0	240.5	20.965	21.940
12" x 8"	175.0	181.5	330.0	286.0	21.600	22.550
12" x 10"	175.0	181.5	330.0	331.2	23.120	24.475
14" x 12"	198.0	197.0	426.6	359.5	32.950	38.500
16" x 12"	238.0	225.5	492.0	418.4	49.000	56.000
16" x 14"	238.0	225.5	492.0	492.0	50.100	56.000

Combination Table of Tee

+ : Tee without Bushing +B: with one Bushing +B*2: with 2 pieces of Bushing

	Branch Size															
	1/2"	3/4"	1"	1-1/4"	1-1/2"	2"	2-1/2"	3"	4"	5"	6"	8"	10"	12"	14"	16"
Main Size	1/2"	+														
	3/4"	+	+													
	1"	+	+	+												
	1-1/4"	+	+	+	+											
	1-1/2"	+	+	+	+	+										
	2"	+	+	+	+	+	+									
	2-1/2"	+B	+B	+B	+B	+	+	+								
	3"	+B	+B	+B	+B	+	+	+	+							
	4"	+B	+B	+B	+B	+B	+	+	+	+						
	5"	+B*2	+B*2	+B	+B	+B	+B	+B	+B	+	+					
	6"	+B*2	+B*2	+B	+B	+B	+B	+B	+	+	+	+				
	8"	+B*2	+B*2	+B	+B	+B	+B	+B	+	+	+B	+	+			
	10"	+B*2	+B*2	+B	+B	+B	+B	+B	+B	+	+B*2	+B	+	+		
	12"	+B*2	+B*2	+B	+B	+B	+B	+B	+B	+	+B*2	+B	+	+	+	
	14"									+B*2	+B*2	+B*2	+B	+B	+	+
	16"									+B*2	+B*2	+B*2	+B	+B	+	+

Reducing Tee

Reducing Tee S X S X FT

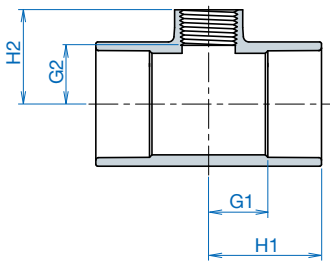

Size	mm				Weight (kg/pc)	
	G1	G2	H1	H2	PVC	CPVC
3/4" x 1/2"	17.10	17.78	42.5	40.0	0.060	0.067
1" x 1/2"	21.42	21.78	50.0	44.0	0.096	0.107
1" x 3/4"	21.42	20.60	50.0	46.0	0.098	0.109
1-1/4" x 1/2"	26.25	25.78	58.0	48.0	0.152	0.170
1-1/4" x 3/4"	26.25	26.60	58.0	52.0	0.154	0.172
1-1/4" x 1"	26.25	25.42	58.0	54.0	0.159	0.178
1-1/2" x 1/2"	30.07	29.78	65.0	52.0	0.200	0.223
1-1/2" x 3/4"	30.07	29.60	65.0	55.0	0.202	0.226
1-1/2" x 1"	30.07	29.42	65.0	58.0	0.207	0.231
1-1/2" x 1-1/4"	30.07	30.25	65.0	62.0	0.216	0.241
2" x 1/2"	35.90	35.78	74.0	58.0	0.281	0.314
2" x 3/4"	35.90	35.60	74.0	61.0	0.283	0.316
2" x 1"	35.90	37.42	74.0	66.0	0.292	0.326
2" x 1-1/4"	35.90	36.25	74.0	68.0	0.303	0.338
2" x 1-1/2"	35.90	36.07	74.0	71.0	0.312	0.349
2-1/2" x 1-1/2"	44.45	42.07	89.0	77.0	0.534	0.596
2-1/2" x 2"	44.45	43.90	89.0	82.0	0.552	0.617
3" x 1-1/2"	53.37	50.07	101.0	85.0	0.711	0.794
3" x 2"	53.37	51.90	101.0	90.0	0.733	0.819
3" x 2-1/2"	53.37	52.55	101.0	97.0	0.768	0.858
4" x 2"	63.85	62.90	121.0	101.0	1.328	1.483
4" x 2-1/2"	63.85	63.55	121.0	108.0	1.326	1.481
4" x 3"	63.85	64.37	121.0	112.0	1.380	1.541
5" x 4"	79.50	78.85	147.5	136.0	1.984	2.216
6" x 3"	95.00	95.37	173.0	143.0	3.350	3.742
6" x 4"	95.00	94.85	173.0	152.0	3.328	3.717
8" x 3"	122.00	122.37	225.0	170.0	7.720	8.623
8" x 4"	122.00	122.85	225.0	180.0	7.860	8.780
10" x 4"	150.00	152.85	290.0	210.0	14.010	15.649
12" x 4"	175.00	183.00	330.0	240.5	21.900	24.090

3 Schedule 80 Fittings

Reducing Bushing

Reducing Bushing
S X S

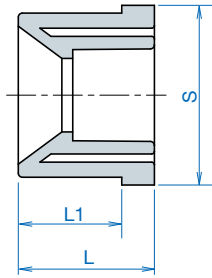

Size	mm			Weight (kg/pc)	
	L	L1	S	PVC	CPVC
3/4" x 1/2"	33	25	30	0.012	0.013
1" x 1/2"	36	29	38	0.027	0.030
1" x 3/4"	36	29	38	0.019	0.021
1-1/4" x 1/2"	41	32	47	0.051	0.057
1-1/4" x 3/4"	41	32	47	0.048	0.054
1-1/4" x 1"	41	32	47	0.036	0.040
1-1/2" x 1/2"	44	35	53	0.067	0.075
1-1/2" x 3/4"	44	35	53	0.068	0.076
1-1/2" x 1"	44	35	53	0.058	0.065
1-1/2" x 1-1/4"	44	35	53	0.034	0.038
2" x 1/2"	50	38	66	0.114	0.127
2" x 3/4"	50	38	66	0.114	0.127
2" x 1"	50	38	66	0.116	0.130
2" x 1-1/4"	50	38	66	0.103	0.115
2" x 1-1/2"	50	38	66	0.085	0.095
2-1/2" x 1-1/2"	55	44	78	0.160	0.179
2-1/2" x 2"	55	44	78	0.118	0.132
3" x 1"	58	48	94	0.244	0.273
3" x 1-1/2"	58	48	94	0.258	0.288
3" x 2"	58	48	94	0.245	0.274
3" x 2-1/2"	58	48	94	0.173	0.193
4" x 1"	70	57	120	0.540	0.603
4" x 1-1/4"	70	57	120	0.602	0.672
4" x 1-1/2"	70	57	120	0.597	0.667
4" x 2"	70	57	120	0.460	0.514
4" x 2-1/2"	70	57	120	0.420	0.469
4" x 3"	70	57	120	0.354	0.395
5" x 4"	82	67	150	0.474	0.529
6" x 3"	92	78	175	1.123	1.254
6" x 4"	92	78	175	1.250	1.396
6" x 5"	92	78	175	0.853	0.953
8" x 4"	120	102	230	2.180	1.396
8" x 6"	120	102	230	2.458	2.746
10" x 6"	158	138	285	4.185	4.675
10" x 8"	158	138	285	4.648	5.192
12" x 6"	174	154	340	7.271	8.122
12" x 8"	174	154	340	7.585	8.472
12" x 10"	174	154	340	6.624	7.399

Combination Table for Reducing Bushing

+:Bushing without Bushing +B: with an additional Bushing +B*2: with two additional Bushing

		Bushing													
		1/2"	3/4"	1"	1-1/4"	1-1/2"	2"	2-1/2"	3"	4"	5"	6"	8"	10"	12"
Bushing	1/2"														
	3/4"	+													
	1"	+	+												
	1-1/4"	+	+	+											
	1-1/2"	+	+	+	+										
	2"	+	+	+	+	+									
	2-1/2"	+B	+B	+B	+B	+	+								
	3"	+B	+B	+	+B	+	+	+							
	4"	+B	+B	+	+	+	+	+	+						
	5"	+B*2	+B*2	+B	+B	+B	+B	+B	+B	+					
	6"	+B*2	+B*2	+B	+B	+B	+B	+B	+	+	+				
	8"	+B*2	+B*2	+B	+B	+B	+B	+B	+B	+	+B	+			
10"	-	-	+B*2	+B*2	+B*2	+B*2	+B*2	+B*2	+B	+B	+	+			
12"	-	-	+B*2	+B*2	+B*2	+B*2	+B*2	+B*2	+B	+B	+	+	+		

Reducing Bushing S X FT

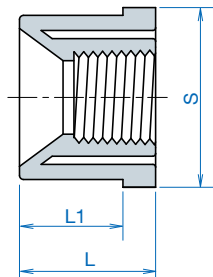

Size	mm			Weight (kg/pc)	
	L	L1	S	PVC	CPVC
3/4" x 1/2"	33	25	30	0.012	0.013
1" x 1/2"	36	29	38	0.027	0.030
1" x 3/4"	36	29	38	0.019	0.021
1-1/4" x 1/2"	41	32	47	0.051	0.057
1-1/4" x 3/4"	41	32	47	0.048	0.054
1-1/4" x 1"	41	32	47	0.036	0.040
1-1/2" x 1/2"	44	35	53	0.067	0.075
1-1/2" x 3/4"	44	35	53	0.068	0.076
1-1/2" x 1"	44	35	53	0.058	0.065
1-1/2" x 1-1/4"	44	35	53	0.034	0.038
2" x 1/2"	50	38	66	0.114	0.127
2" x 3/4"	50	38	66	0.114	0.127
2" x 1"	50	38	66	0.116	0.130
2" x 1-1/4"	50	38	66	0.103	0.115
2" x 1-1/2"	50	38	66	0.085	0.095
2-1/2" x 1-1/2"	55	44	78	0.160	0.179
2-1/2" x 2"	55	44	78	0.118	0.132
3" x 1"	58	48	94	0.244	0.273
3" x 1-1/2"	58	48	94	0.258	0.288
3" x 2"	58	48	94	0.245	0.274
3" x 2-1/2"	58	48	94	0.173	0.193
4" x 1"	70	57	120	0.540	0.603
4" x 1-1/4"	70	57	120	0.602	0.672
4" x 1-1/2"	70	57	120	0.597	0.667
4" x 2"	70	57	120	0.460	0.514
4" x 2-1/2"	70	57	120	0.420	0.469
4" x 3"	70	57	120	0.354	0.395
5" x 4"	82	67	150	0.474	0.529
6" x 3"	92	78	175	1.123	1.254
6" x 4"	92	78	175	1.250	1.396
8" x 4"	120	102	230	2.180	1.396

3 Schedule 80 Fittings

Male Adapter

Male Adapter
Mpt X S

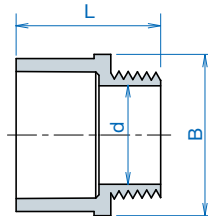

Size	mm			Weight (kg/pc)	
	L	d	B	PVC	CPVC
1/2"	46	13	33	0.023	0.026
3/4"	50	18	39	0.025	0.028
1"	56	24	47	0.040	0.045
1-1/4"	63	32	58	0.064	0.071
1-1/2"	66	37	64	0.090	0.101
2"	73	49	77	0.120	0.134
2-1/2"	93	58	94	0.220	0.246
3"	98	72	111	0.300	0.335
4"	112	96	139	0.510	0.570

Female Adapter

Female Adapter
S X FT

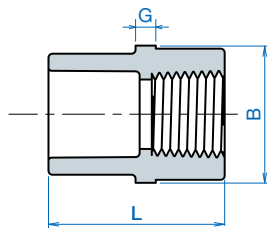

Size	mm			Weight (kg/pc)	
	L	G	B	PVC	CPVC
1/2"	44	5	33	0.031	0.034
3/4"	47	5	38	0.042	0.046
1"	54	6	46	0.063	0.069
1-1/4"	60	6	56	0.103	0.113
1-1/2"	65	7	64	0.143	0.157
2"	70	10	77	0.219	0.239
2-1/2"	92	10	91	0.336	0.367
3"	96	12	107	0.517	0.564
4"	108	13	138	0.782	0.853

Cap

Socket Cap

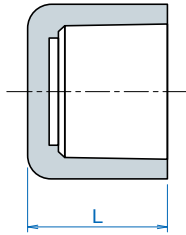

Size	mm		Weight (kg/pc)	
	L		PVC	CPVC
1/2"	30.0		0.015	0.017
3/4"	36.0		0.025	0.029
1"	41.0		0.040	0.046
1-1/4"	47.0		0.065	0.074
1-1/2"	52.0		0.105	0.120
2"	59.0		0.150	0.172
2-1/2"	67.0		0.245	0.280
3"	77.0		0.435	0.497
4"	92.0		0.620	0.709
5"	107.0		0.915	1.046
6"	124.0		1.480	1.692
8"	165.0		2.790	3.190
10"	191.0		5.355	6.121
12"	215.0		8.136	9.300

Threaded Cap

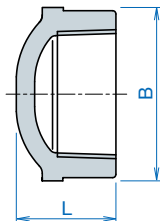

Size	mm		Weight (kg/pc)	
	L	B	PVC	CPVC
1/2"	28.0	32.5	0.020	0.022
3/4"	31.0	38.1	0.029	0.032
1"	37.0	46.0	0.046	0.050
1-1/4"	41.0	56.0	0.073	0.080
1-1/2"	42.0	63.5	0.110	0.120
2"	46.0	77.0	0.149	0.163
2-1/2"	65.5	91.0	0.257	0.281
3"	73.0	107.0	0.431	0.471
4"	84.5	138.0	0.592	0.646

3 Schedule 80 Fittings

Plug

Cap and Plug
Mpt Plug

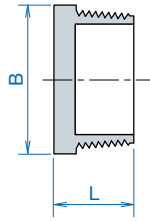

Size	mm		Weight (kg/pc)	
	L	B	PVC	CPVC
1/2"	24.5	24	0.008	0.009
3/4"	25.0	30	0.012	0.013
1"	28.0	38	0.026	0.028
1-1/4"	32.5	47	0.034	0.037
1-1/2"	33.0	53	0.045	0.049
2"	36.5	65	0.085	0.093
2-1/2"	50.0	79	0.128	0.140
3"	52.0	95	0.193	0.211
4"	54.5	120	0.347	0.379

Nipple

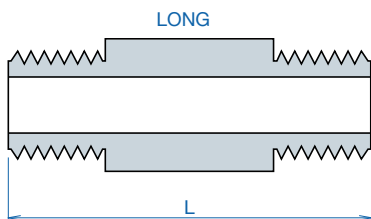
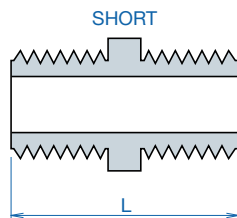
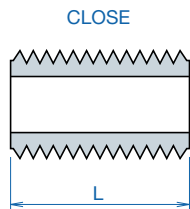

Size	mm	Weight (kg/pc)	
	L	PVC	CPVC
1/2"	1-3/4", 2", 3", 4", 5", 6", 8", 10", 12"	-	-
3/4"	1-3/4", 2", 3", 4", 5", 6", 8", 10", 12"	-	-
1"	2", 3", 4", 5", 6", 8", 10", 12"	-	-
1-1/4"	2", 3", 4", 5", 6", 8", 10", 12"	-	-
1-1/2"	2", 3", 4", 5", 6", 8", 10", 12"	-	-
2"	2", 3", 4", 5", 6", 8", 10", 12"	-	-
2-1/2"	3", 4", 5", 6", 8", 10", 12"	-	-
3"	4", 5", 6", 8", 10", 12"	-	-
4"	4", 5", 6", 8", 10", 12"	-	-

4 True Union

Union (O-Ring Seat)

Union (O-Ring Seat) S X S

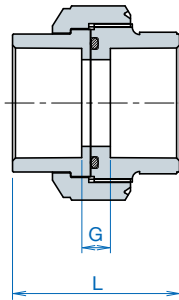

O-ring: EPDM. FKM

Size	mm		Weight (kg/pc)	
	L	G	PVC	CPVC
1/2"	52	6.5	0.046	0.050
3/4"	59	7.5	0.073	0.079
1"	67	8.0	0.130	0.143
1-1/4"	76	12.5	0.204	0.223
1-1/2"	82	10.5	0.269	0.294
2"	92	14.0	0.426	0.468
2-1/2"	108	19.0	0.656	0.719
3"	120	25.0	1.076	1.159
4"	152	37.0	1.862	2.031

Union (O-Ring Seat) FT X FT

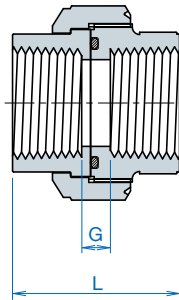

O-ring: EPDM. FKM

Size	mm		Weight (kg/pc)	
	L	G	PVC	CPVC
1/2"	52	7.6	0.046	0.050
3/4"	59	8.2	0.073	0.079
1"	67	7.2	0.130	0.143
1-1/4"	76	9.2	0.204	0.223
1-1/2"	82	8.5	0.269	0.294
2"	92	12.0	0.426	0.468
2-1/2"	108	19.1	0.656	0.719
3"	120	24.7	1.076	1.159
4"	152	37.7	1.862	2.031

5 Flange

One Piece Flange

Flange (ANSI) - Socket (ASTM)

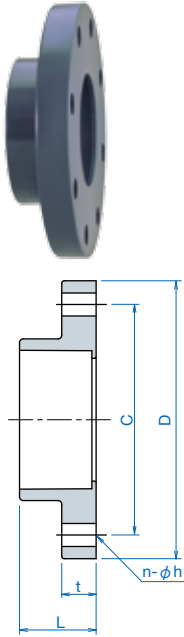

Size	mm						Weight (kg/pc)	
	L	t	C	D	n	h	PVC	CPVC
1/2"	25.0	11.5	60.3	89.0	4	15.7	0.094	0.105
3/4"	29.5	13.0	69.0	98.8	4	15.7	0.120	0.134
1"	32.0	14.5	79.5	108.3	4	15.7	0.190	0.212
1-1/4"	38.5	17.6	88.9	118.8	4	15.7	0.240	0.268
1-1/2"	40.5	19.0	98.4	127.5	4	15.7	0.310	0.346
2"	46.6	19.5	120.6	152.0	4	19.1	0.458	0.512
2-1/2"	51.0	22.5	139.5	177.0	4	19.1	0.715	0.799
3"	55.0	27.1	152.4	192.8	4	19.1	0.880	0.983
4"	64.0	29.3	190.5	229.7	8	19.1	1.340	1.497
5"	82.0	28.0	215.9	254.0	8	22.4	1.648	1.841
6"	84.5	25.5	241.3	279.0	8	22.4	2.220	1.944
8"	116.0	29.0	298.4	343.0	8	22.4	3.400	3.798

NOTE: Flange bolt hole patterns meet ANSI B16.5, class 150

Flange (JIS) - Socket (ASTM)

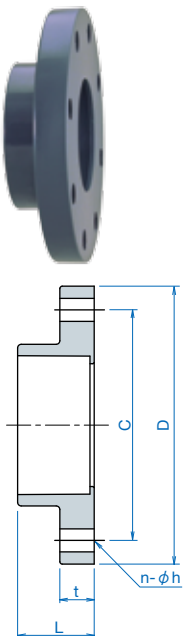

Size	mm						Weight (kg/pc)	
	L	t	PCD	D	n	h	PVC	CPVC
1/2"	25.0	14.0	70	95	4	15	0.096	0.107
3/4"	29.5	14.0	75	100	4	15	0.123	0.137
1"	32.0	14.0	90	125	4	19	0.195	0.218
1-1/4"	38.5	16.0	100	135	4	19	0.247	0.276
1-1/2"	40.5	16.0	105	140	4	19	0.320	0.358
2"	45.0	20.0	120	155	4	19	0.473	0.528
2-1/2"	51.0	22.0	140	175	4	19	0.660	0.712
3"	55.0	22.0	150	185	8	19	0.685	0.762
4"	64.0	22.0	175	210	8	19	0.945	0.984
5"	82.0	24.0	210	250	8	23	1.405	1.508
6"	84.5	25.5	240	280	8	23	1.835	1.956
8"	116.0	28.0	290	330	12	23	2.920	3.212

NOTE: Flange bolt hole patterns meet JIS B2220

Flange (ANSI) - Threaded

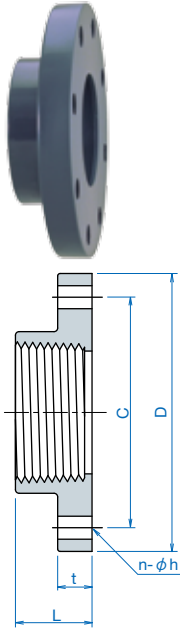

Size	mm						Weight (kg/pc)	
	L	t	C	D	n	h	PVC	CPVC
1/2"	25.0	11.5	60.3	89.0	4	16	0.094	0.105
3/4"	29.5	13.0	69.0	98.8	4	16	0.120	0.134
1"	32.0	14.5	79.5	108.3	4	16	0.190	0.212
1-1/4"	38.5	18.3	88.9	118.5	4	16	0.240	0.268
1-1/2"	40.5	17.5	98.4	127.5	4	16	0.310	0.346
2"	45.0	19.5	120.6	152.0	4	19	0.458	0.512
2-1/2"	51.0	22.5	139.5	177.0	4	19	0.715	0.799
3"	55.0	24.0	152.4	191.0	4	20	0.880	0.983
4"	64.0	24.0	190.5	229.7	8	19	1.340	1.497

NOTE: Flange bolt hole patterns meet ANSI B16.5, class 150

Van Stone Flange

Flange (ANSI) - Socket (ASTM)

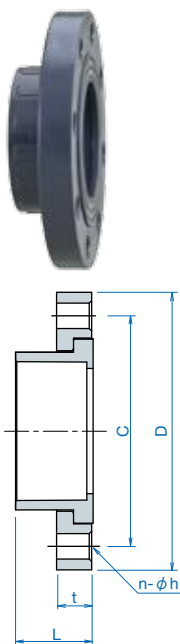

Size	Pressure MPa	mm						Weight (kg/pc)	
		L	t	C	D	n	h	PVC	CPVC
2"	1.0	43.0	20.0	120.6	152.0	4	19.1	0.375	0.405
2 1/2"	1.0	51.0	24.5	139.5	178.0	4	19.1	0.600	0.696
3"	1.0	55.0	27.0	152.4	191.0	4	19.1	0.734	0.800
4"	1.0	64.0	28.0	190.5	229.0	8	19.1	1.090	1.245
5"	1.0	82.0	28.0	216.0	254.0	8	22.4	1.440	1.550
6"	1.0	85.0	32.0	241.3	283.2	8	22.4	1.895	2.002
8"	1.0	120.5	36.0	298.5	343.0	8	22.4	3.510	3.831
10"	1.0	150.0	42.0	362.0	406.0	12	25.4	5.105	5.451
12"	1.0	190.0	42.0	432.0	483.0	12	25.4	9.240	9.920
14"	1.0	203.0	51.0	476.2	533.0	12	28.4	11.260	12.329
16"	1.0	225.0	60.0	539.8	597.0	16	28.4	16.104	17.885
18"	1.0	248.0	60.0	577.8	635.0	16	31.8	20.855	22.763
20"	0.6	280.0	17.5	635.0	699.0	20	31.8	36.627	38.430
	1.0		47.751					49.554	
24"	0.6	344.0	19.0	749.0	813.0	20	35.1	60.558	61.931
	1.0		75.704					77.077	

NOTE: Flange bolt hole patterns meet ANSI B16.5, class 150

5 Flange

Van Stone Flange

Flange (JIS) - Socket (ASTM)

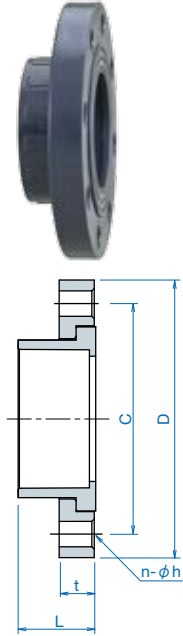

Size	mm						Weight (kg/pc)	
	L	t	C	D	n	h	PVC	CPVC
2"	43.0	20.0	120.0	153.0	4	20.0	0.405	0.425
2-1/2"	51.0	24.5	140.0	178.3	4	20.0	0.615	0.696
3"	55.0	27.0	150.0	185.0	8	19.0	0.684	0.760
4"	64.0	28.0	175.0	210.0	8	19.0	0.920	0.990
5"	82.0	28.0	210.0	250.0	8	23.0	1.370	1.495
6"	85.0	32.0	240.0	283.4	8	23.0	1.910	1.997
8"	120.5	36.0	290.0	330.0	12	23.0	3.160	3.449
10"	150.0	42.0	355.0	400.0	12	25.0	5.140	5.390
14"	203.0	14.0	445.0	490.0	16	25.0	12.775	13.373
16"	225.0	14.0	510.0	560.0	16	27.0	18.290	18.850
18"	248.0	14.0	565.0	620.0	20	27.0	23.945	25.277
20"	280.0	15.0	620.0	675.0	20	27.0	34.300	36.103
24"	344.0	15.0	730.0	795.0	24	33.0	59.350	60.723

NOTE: Flange bolt hole patterns meet JIS B2220

Blind Flange

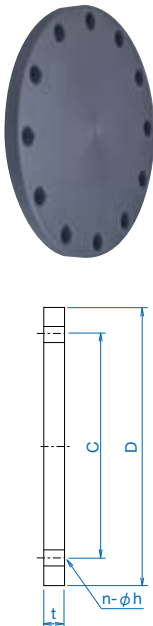

Size	mm					Weight (kg/pc)	
	t	C	D	n	h	PVC	CPVC
1/2"	12	60.3	89	4	16	0.108	0.121
3/4"	13	70.0	98	4	16	0.148	0.165
1"	15	79.5	108	4	16	0.216	0.241
1-1/4"	16	89.0	117	4	16	0.254	0.284
1-1/2"	18	98.5	127	4	16	0.295	0.329
2"	18	120.5	152	4	19	0.463	0.518
2-1/2"	22	139.5	178	4	19	0.755	0.843
3"	24	152.5	191	4	19	0.928	1.037
4"	24	190.5	229	8	19	1.501	1.676
5"	26	216.0	254	8	22	1.746	1.950
6"	26	241.5	282	8	22	2.229	2.489
8"	28	298.5	343	8	22	3.410	3.809
10"	28	362.0	406	12	25	4.842	4.966
12"	28	432.0	483	12	25	7.005	7.215
14"	45	476.3	535	12	29	12.485	12.889
16"	45	539.8	595	16	29	15.359	16.893
18"	45	577.9	635	16	32	17.942	19.735
20"	45	635.0	700	20	32	21.642	23.803
24"	45	749.3	815	20	35	28.130	30.940

NOTE: Flange bolt hole patterns meet ANSI B16.5 class 150

Eslon PTFE Gasket

Eslon PTFE Gasket ANSI B16.5

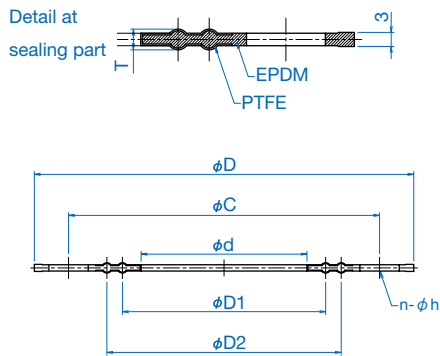

Size	mm							Weight (kg/pc)	N-m{kgf-cm}
	d	D1	D2	C	D	n- ϕ h	T		
1/2"	18	30	-	60.3	85	4-16	5	0.022	16{160}
3/4"	22	32	44	69.9	95	4-16	5	0.029	16{160}
1"	29	38	50	79.4	103	4-16	5	0.034	35{350}
1-1/4"	39	47	59	88.9	111	4-16	5	0.039	35{350}
1-1/2"	44	53	68	98.4	121	4-16	5	0.044	35{350}
2"	55	65	83	120.7	146	4-19	5	0.065	35{350}
2-1/2"	70	81	101	139.7	173	4-19	5	0.084	52{520}
3"	81	94	112	152.4	186	4-19	5	0.098	52{520}
4"	103	124	148	190.5	223	8-19	5	0.137	52{520}
5"	128	150	174	215.9	249	8-22	5	0.153	68{680}
6"	152	172	196	241.3	274	8-22	5	0.182	68{680}
8"	200	222	246	398.5	337	8-22	5	0.258	63{630}
10"	251	276	300	362.0	401	12-25	6	0.348	102{1020}
12"	302	335	365	431.8	477	12-25	6	0.484	136{1360}

Eslon EPDM Gasket

Eslon EPDM Gasket ANSI B16.5

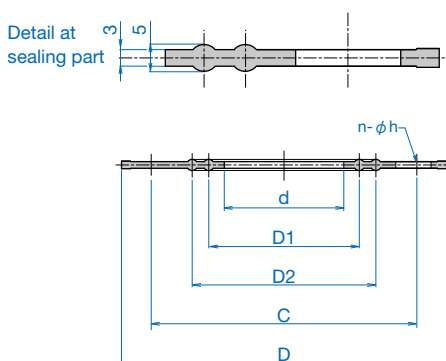

Size	mm						Weight (kg/pc)	N-m{kgf-cm}
	d	D1	D2	C	D	n- ϕ h		
1/2"	18	25	38	60.5	86	4-16	0.017	14{140}
3/4"	23	33	48	70.1	97	4-16	0.021	14{140}
1"	30	38	53	79.5	107	4-16	0.025	20{200}
1-1/4"	38	51	66	88.9	114	4-16	0.029	20{200}
1-1/2"	43	53	69	98.6	124	4-16	0.034	20{200}
2"	53	69	84	120.7	150	4-19	0.049	34{340}
2-1/2"	49	86	102	139.7	175	4-19	0.066	34{340}
3"	81	99	112	152.4	188	4-19	0.074	41{410}
4"	102	119	137	190.5	226	8-19	0.101	41{410}
5"	127	145	165	215.9	251	8-22	0.117	55{550}
6"	149	168	191	241.3	277	8-22	0.134	68{680}
8"	198	216	246	298.5	340	8-22	0.192	68{680}
10"	249	269	307	362.0	404	12-25	0.246	89{890}
12"	300	325	353	431.8	480	12-25	0.356	102{1020}



Eslon Sch80 PVC & CPVC Piping System

3

Installation

1 Storage and Handling.....	33
2 General Recommendations.....	35
3 Rules and Guidelines.....	36

1 Storage and Handling

Buyer's Acceptance of Materials

The person responsible for receiving the pipe should always carefully inspect as much of the pipe as possible before unloading. The receiver should look for transportation damage such as a shift in the load, tie-down straps overtightened, or signs of rough treatment. LTL (less than truckload) pipe shipments that arrive in a closed trailer should be checked as soon as the trailer is opened. Make sure that the pipe has not been toploaded with metallic piping, crates, machinery or any other objects that might crush or impact the plastic pipe. The ends of the pipe should be visually inspected for cracks, cuts, gouges, or heavy deformations. In some cases, especially for large diameter pipe 4" and above, it would be advisable to inspect the bore of the pipes for internal cracks or splits that may have occurred as a result of loading or transportation. The use of a strong flashlight may be necessary to inspect the inside diameter beyond the ends of the pipe. Any and all damages should be witnessed by the truck driver and clearly noted on the transportation documentation with a copy retained by the receiver. The carrier and Eslon should be immediately notified of any damages or missing pipe, or items incorrectly shipped.

Unloading and Handling

After the pipe has been thoroughly inspected and inventoried, it should be unloaded with reasonable care and effort. The person receiving the pipe must decide the means by which the pipe is unloaded and is responsible for any damages that occur during the unloading process. Never push or drag a palletized load of pipe from a truck bed. Pipe should not come into severe contact with sharp objects such as corners of truck beds, loading docks and buildings, forks on forklift trucks, and rocks or other objects on the ground. Forklift forks must never be inserted into the ends of the pipe as a means of lifting or moving.

Handling and Storing on Site

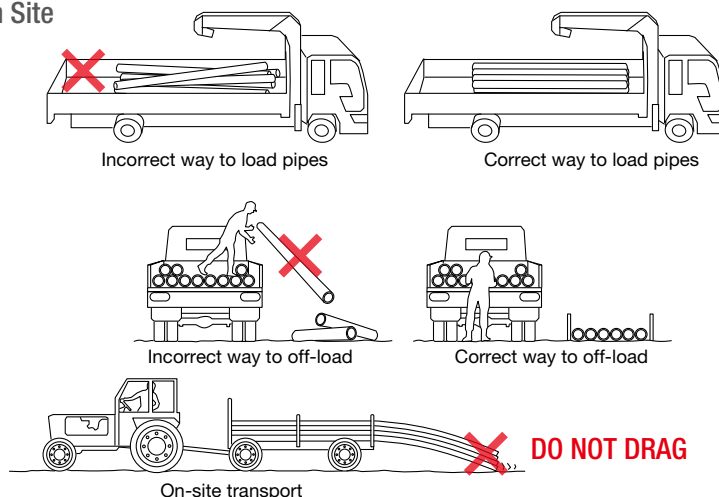

NOTE: The impact resistance and flexibility of PVC and especially CPVC pipe are reduced by lower temperature conditions. The impact strength for both types of piping materials will decrease as temperatures approach 32°F (0°C) and below. Extreme care should be taken when unloading and handling pipe in cold weather. Dropping pipe from a truck or forklift can cause damage. Methods and techniques normally used in warm weather may not be acceptable at the lower temperature range.

Pipe Storage

Indoor storage of pipe is recommended but may not always be convenient. Therefore, when storing pipe outdoors, choose a flat, dry location that will minimize dirt and foreign matter accumulation in the bore and belled end. Palletized pipe should be stacked with wooden pallet bracings touching each other. Stack height will depend on the pipe diameter, the slope of the terrain, and the weather conditions. As a general precaution, palletized pipe should not be stacked higher than eight feet. This should be determined and approved by the site engineer or responsible management official. Loose pipe lengths should be stored in racks or dunnage that will evenly support the pipe to prevent longitudinal sag. If pipe is not well supported, especially in warmer weather, it will become permanently bowed and will be difficult to install. The pipe must be protected from the sun and extreme heat. Protect the pipe by covering it with an opaque tarp, leaving the ends open to allow for air circulation through and around the pipe. When pipe is not protected from the sun, extended exposure to ultraviolet rays will cause discoloration. The amount of time in years necessary to cause this will vary with the geographic location and the orientation of the pipe to the sun.

Outdoor Storage

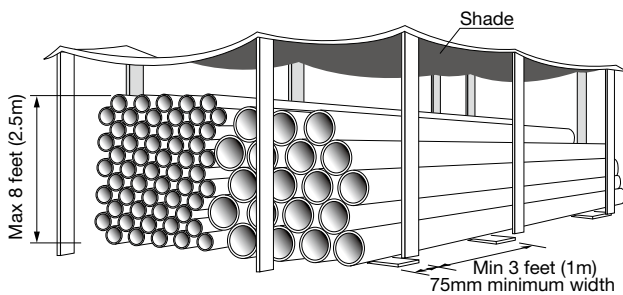

Indoor Storage

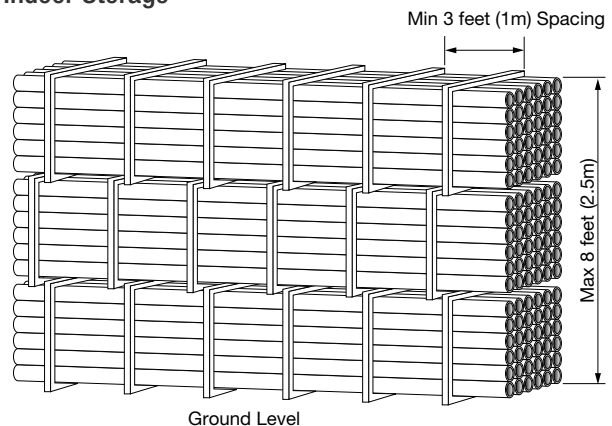

Fitting Storage

The person responsible for receiving the fittings should take an accurate count of the incoming order and report any discrepancies to Esilon and the carrier. Fittings packaged in damaged boxes should be closely inspected. Store fittings in their original packaging. If they must be removed from their boxes, separate them by material type (PVC vs. CPVC), geometric configuration, and diameter size. Never combine your plastic fitting inventory with metallic materials. Avoid storing fittings near an open flame or source of extreme heat.

2 General Recommendations

WARNING

Failure to follow the safety precautions below may result in misapplication or improper installation and testing which can cause severe personal injury and/or property damage.

1. Solvent Cement Welding

This method of joining is very simple and reliable if it is followed correctly, but any deviations from the recommended basic steps may reduce the strength and integrity of the joint. The procedures for preparation, insertion, and curing should be followed very carefully.

2. Expansion and Contraction

The coefficient of linear expansion of PVC and CPVC pipe is greater than that of metallic piping; therefore, take this factor into consideration when designing and installing a PVC or CPVC piping system.

3. Hanging and Supporting

The modulus of elasticity of PVC and CPVC pipe is smaller than that of metal pipes. Maximum working temperature and room temperature should be considered when determining the required support spacing.

4. Trench Preparation

When laying PVC and CPVC pipe below the ground, care should be taken to remove all rocks, boards, empty primer and cement cans, brushes, bottles and other debris from the trench. Smaller diameters of pipe should be “snaked” in the trench to allow for expansion and contraction. If solvent cement welding is used for the method of joining, snaking, pressure testing, and pipe movement should not be done until after the joints have been given sufficient time to dry.

5. Avoid Bending Pipe

Pipe should not be bent in trenches or in above ground installations. Pipe and joints that are stressed can reduce pressure rating and cause failures.

6. Protect Plastic Pipe from Contact with Hard and Pointed Objects.

Impact resistance is lower than for metals.

WARNING

NEVER use compressed air or gas in PVC/CPVC pipe and fittings.
NEVER test PVC/CPVC pipe and fittings with compressed air or gas, or air-over-water boosters.
ONLY use PVC/CPVC pipe for water and approved chemicals.

Use of compressed air or gas in PVC/CPVC pipe and fittings can result in explosive failures and cause severe injury or death.

7. Testing

7.1 NEVER use compressed air, gas or air-over-water boosters to pressure test PVC or CPVC piping systems. ONLY hydrostatic pressure testing is to be conducted on PVC and CPVC piping systems. Compressed air or gases can surge to high pressures and cause explosive failures that could seriously injure personnel.

7.2 Carefully follow all instructions for hydrostatic pressure testing. Failure to follow these instructions can result in a system failure.

7.3 Before water-testing a system, always bleed all entrapped air from system. Entrapped air is a major cause of surge and burst failure in plastic piping systems.

3 Rules and Guidelines

Solvent Cement Welding Joints

Joining Equipment and Material

- **Cutting Tool**
Saw & Miter Box or Pipe Cutter (Ratchet Type, Wheel Type)
- **Pipe deburring & beveling tool, file or knife**
- **Solvent Cement**
PVC cement for PVC materials, CPVC cement for CPVC materials
- **Primer**
- **Cleaner**
- **Cotton Rag**
- **Square**
- **Scale**
- **Felt-tip Pen**
- **Tape Measure**
- **Brush**
- **Insertion Tool (6" and above)**
- **Container (Metal Cans to Hold Cement or Primer)**



1. Cutting ①②③④

Pipe ends must be cut square.

Check the pipe end with a square to make sure it has been cut squarely.

Note: A diagonal cut reduces bonding area in the most effective and critical part of the joint.

Wheel type cutters are not generally recommended for large diameters since they tend to raise flare at the pipe end.

This flare must be removed with a file or deburring tool, as it will scrape the cement away when pipe is inserted into the fitting.

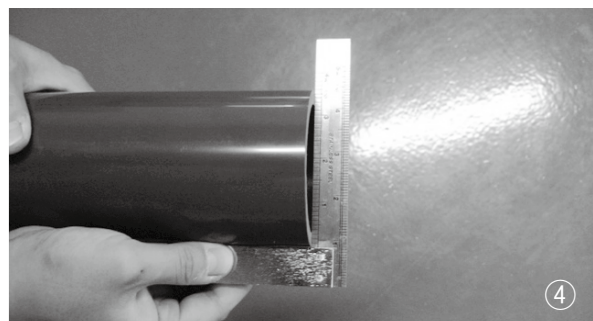
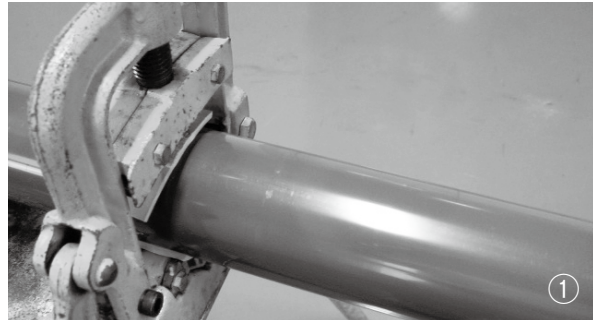

3 Rules and Guidelines

2. Deburring ⑤

All burrs, chips, filings, etc., should be removed from both around the pipe before joining.

Use a knife, deburring tool or a half-round coarse file.

All pipe ends should be beveled from 45 degrees.

Note: Failure to chamfer the edge of the pipe may remove cement from the fitting socket, causing the joint to leak.



3. Inspection, Cleaning ⑥⑦

Visually inspect the inside of the pipe and fitting sockets and remove all dirt, grease or moisture with a clean dry rag.

Check pipes and fittings possible damage such as splits or cracks and replace if necessary.



4. Test Dry Fit of the Joint

Check pipe and fittings for dry fit before cementing. The pipe should be inserted to the fitting easily about 1/3 to 2/3 of the socket depth.

5. Depth-Of-Entry Mark ⑧⑨

Measure the socket depth of the fitting and mark this distance on the pipe O.D.

This reference mark can be used when joining to ensure the pipe is completely bottomed into the fitting during assembly.

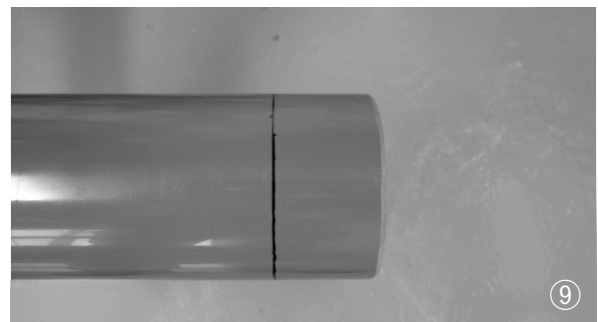
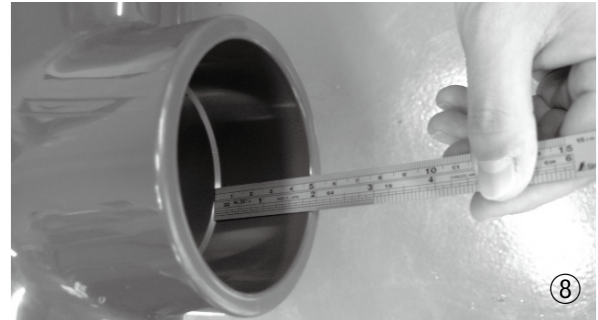

6. Priming ⑩⑪

This process is necessary to penetrate and soften both pipe and fitting socket surfaces for cementing process.

Apply primer to the surface of the pipe and fitting socket with a natural bristle brush.

Move quickly without hesitation to the cementing procedure while surfaces are still wet with primer.



Recommended Brush Size for Primer and Cement Application

Nominal Pipe Size	1/2	3/4	1	1-1/4	1-1/2	2	2-1/2	3	4	5	6	8	10	12
Brush Width	1/2	1	1	1	1-1/2	1-1/2	1-1/2 to 2	1-1/2 to 2-1/2	2 to 3	3	3 to 5	4 to 6	6 to 8	6 to 8

* Use Only Natural Bristle

7. Application of Solvent Cement ⑫⑬

Apply the solvent cement evenly and quickly around the outside of the pipe at a width a little greater than the depth of the fitting socket while the primer is still wet.

Apply a light coat of cement evenly around the inside of the fitting socket. Avoid puddling.

Apply a second coat of cement to the pipe end.

NOTE: Read all warnings on primer and cement cans.

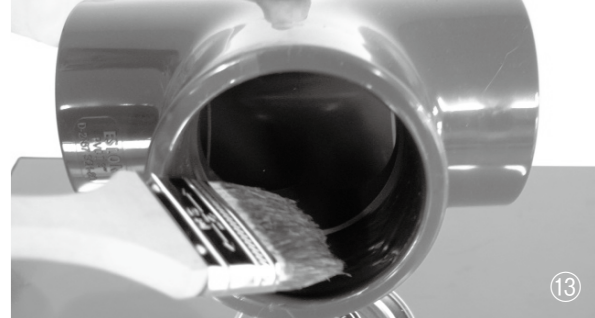

8. Joint Assembly ⑭

Work quickly, insert the pipe into the fitting socket bottom with a one-quarter turn to evenly distribute the cement.

Do not continue to rotate the pipe after it has reached the bottom of the fitting socket.

A good joint will have sufficient cement to make a bead all the way around the outside of the fitting hub.

Hold the pipe and fitting together for a minimum of 30 seconds to make sure the pipe does not move or push out of the socket.



9. Cleanup ⑮

Remove all excess cement from around the pipe and fitting with a dry cotton rag while the cement is still soft.



3 Rules and Guidelines

10. Initial Set Time

Initial set time is the necessary time to allow before the joint can be carefully handled.

Initial Set Schedule

Temperature Range	Pipe Sizes 1/2" to 1-1/4"	Pipe Sizes 1-1/2" to 2"	Pipe Sizes 2-1/2" to 8"	Pipe Sizes 10" to 15"	Pipe Sizes 15"+
60 to 100°F	2 min	5 min	30 min	2 hrs	4 hrs
40 to 60°F	5 min	10 min	2 hrs	8 hrs	16 hrs
0 to 40°F	10 min	15 min	12 hrs	24 hrs	48 hrs

Note: In damp or humid weather allow 50% more set time.

11. Joint cure time

Joint cure time is the necessary time to allow before pressurizing system.

Joint Cure Schedule

inch-lb Unit

Temperature range during assembly and cure periods	Pipe Sizes 1/2" to 1-1/4"	Pipe Sizes 1-1/2" to 2"	Pipe Sizes 2-1/2" to 8"	Pipe Sizes 10" to 15"	Pipe Sizes 15"+
	up to 150psi	up to 150psi	up to 150psi	up to 100psi	up to 100psi
60 to 100°F	1 hour	2 hours	6 hours	48 hours	72 hrs
40 to 60°F	2 hours	4hours	12 hours	96 hours	6 days
20 to 40°F	8 hours	16 hours	72 hours	8 days	14 days

S I Unit

Temperature range during assembly and cure periods	Pipe Sizes 1/2" to 1-1/4"	Pipe Sizes 1-1/2" to 2"	Pipe Sizes 2-1/2" to 8"	Pipe Sizes 10" to 15"	Pipe Sizes 15"+
	up to 1MPa	up to 1MPa	up to 1MPa	up to 0.7MPa	up to 0.7MPa
15 to 40°C	1 hour	2 hours	6 hours	48 hours	72 hrs
5 to 15°C	2 hours	4hours	12 hours	96 hours	6 days
- 5 to 5°C	8 hours	16 hours	72 hours	8 days	14 days

Note: In damp or humid weather allow 50% more cure time.

Helpful Hints

1. Work quickly and carefully.
2. Use liberal amounts of fresh cement.
3. Do not attempt cementing in the rain or in the presence of moisture.
4. Do not cement when the temperature is below 40°F or above 90°F under direct sunlight.
5. Do not take shortcuts or bypass recommended steps.
6. Consult your cement manufacturer for specific questions or problems

Applicable Specification for Solvent Welding

ASTM D-2564 : Solvent cements for PVC plastic pipe and fitting

ASTM D-2855 : Marking solvent cemented joint with PVC pipe and fitting

ASTM A-493 : Solvent cements for CPVC plastic pipe and fitting

ASTM A-656 : Primers for use in solvent cement joints of PVC plastic pipe and fitting

Hydrostatic Pressure Testing

⚠ WARNING	
	<p>Failure to follow the safety precautions below may result in misapplication or improper installation and testing which can cause severe personal injury and/or property damage.</p>

1. The last assembled joint should be fully cured before filling the system with water.
2. All valves and air relief mechanisms should be opened at the ends and elevations. The system should be filled slowly, flow velocities should not exceed 1 foot per second. This will prevent surge, water hammer, and air entrapment.
3. Water flow should continue until all entrapped air is completely flushed out of every branch of the system. Maintain the 1 ft/s velocity until every valve is checked. A rapid fluctuation of gauge needle during pressure rise may be an indication that entrapped air still remains in the system. Systems should include the appropriate air relief and vacuum breaker valves to vent air during normal operation after installation. Entrapped air is major cause of surge and burst failure in plastic piping systems.
4. After filling the system, do not pressurize until the responsible engineer is present to witness the test. All personnel in the vicinity of the system should wear safety glasses and hard hats. High voltage electrical equipment should be shielded from a possible spray.
5. The piping system should be pressurized to

125% of its maximum design operating pressure. This pressure must not exceed 1.5 times the working pressure of the lowest rated component in the system, i.e. flanges, unions, thread parts, valves, etc.

6. The pressure test should not exceed 1 hour. This should provide enough time to inspect all joints for leaks. If leaks are found, pressure must be relieved to repair the leak. The system should then be recharged and retested. Consult the factory if you have any questions concerning these steps.

⚠ CAUTION
<p>“CAUTION” identifies hazards or unsafe practices which can result in minor injury or product or property damage if instructions, including recommended precautions, are not followed.</p>

Applicators

Select a suitable pure bristle type paint brush. Use a proper width brush or roller to apply the primer and cement (see chart below). Speedy application of cement is important due to its fast drying characteristics.

IMPORTANT NOTE: A dauber type applicator should only be used on pipe sizes 2” and below. For larger diameter pipe, a brush, swab, or roller must be used.

3 Rules and Guidelines

2 Threaded Connection

A. Selection of Materials

- Power Threading Machine
- Threading Ratchet and Pipe Vise (if hand pipe stock is used)
- Pipe Dies designed for plastic
- Strap Wrench
- Teflon* Tape or an approved Teflon Paste
- Cutting and Deburring Tool
- Ring Gauge (L-1)
- *Trademark of the EJ DuPont Company

B. Making the Pipe Thread

1. Cutting and Deburring

PVC or CPVC pipe should be cut square and smooth for easy and accurate threading. A miter box or similar guide should be used when sawing is done by hand. Burrs should be removed inside and out using a knife or plastic pipe deburring tool.

2. Threading

Threading Schedule 80 PVC and CPVC pipe can easily be accomplished using either a standard hand pipe stock or a power operated tool. Cutting dies should be clean and sharp. Power threading machines should be fitted with dies having a 5° negative front rake and ground especially for plastic pipe. Self-opening die heads, and a slight chamfer to lead the dies will speed the operation; however, dies should not be driven at high speeds or with heavy pressure. When using a hand held cutter, the pipe should be held in a pipe vise. To prevent crushing or scoring of the pipe by the vice jaws, some type of protective wrap such as canvas, emery paper, rubber, or light metal sleeve should be used. For hand stocks, the dies should

have a negative front rake angle of 5° to 10° PVC and CPVC is readily threaded and caution should be taken not to over-thread.

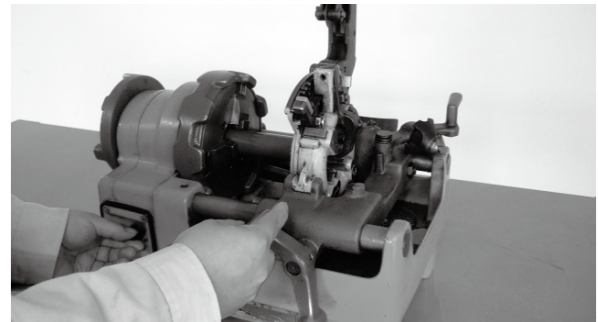
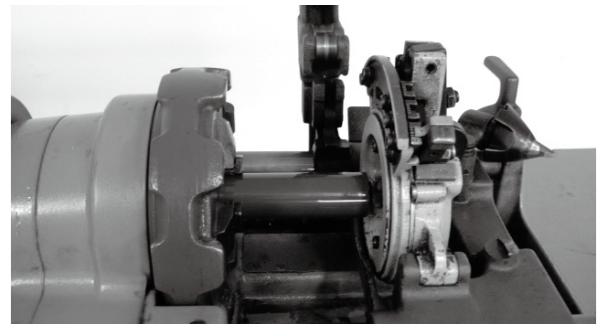

3. Preparing the Threaded Pipe

A ring gauge should be used to check the accuracy of the threads. Tolerance = $\pm 1-1/2$ turns. The threads should then be cleaned by brushing away cuttings and ribbons.

After cleaning, apply a thread lubricant such as Teflon tape to the threaded portion of pipe. Wrap the tape around the entire length of threads beginning with number two thread from the end. The tape should slightly overlap itself going in the same direction as the threads. This will prevent the tape from unraveling when the fitting is tightened on the pipe. Overlapping in the wrong direction and the use of too much tape can affect tolerances between threads. This can generate stress in the wall of female fittings resulting in failure during operations.

4. Assembly of Threaded Joints

After applying thread lubricant, screw the threaded fitting onto the pipe. Screwed fittings should be started carefully and hand tightened. Threads must be properly cut and a good quality thread lubricant/tape must be used. If desired, the joint may be tightened with a strap wrench. IN NO CASE SHOULD A STILLSON TYPE WRENCH BE USED. The jaws of this type of wrench will scar and damage the pipe wall. Fittings should be threaded together until hand tight with an additional 1 to 1-1/2 turns more. Avoid stretching or distorting the pipe, fittings or threads by over tightening.

NOTE:

(1.) Never apply solvent cement to threaded pipe or threaded fittings. Do not allow cleaners, primers, or solvent cements to “run” or drip into the threaded portion of the fitting.

(2.) Some Teflon pastes contain chemicals that may be harmful to the pipe and fittings. You should consult the supplier or manufacturer of the paste before use.

(3.) Avoid screwing metallic male threads into plastic female threads. If connections to metal threads have to be made, the preferred method is to screw a plastic male thread into a metallic female thread. There are a variety of plastic fittings that are molded with metallic male or female NPT threaded inserts. The corrosion resistance of the metal insert will have to be taken into consideration. Consult the factory or your Eslon sales person for the availability of these metal insert fittings.

***Trademark of the E.I. DuPont Company.**



ANSI B1.20.1 Taper Pipe Thread Dimensions

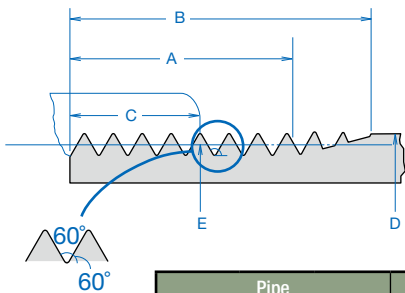

Nominal Size	Pipe		Number of Threads Per Inch	Threads									
	Outside Diameter D			Normal Engagement By Hand C		Length of Effective Thread A		Total Length : End of pipe to vanish point B		Pitch Diameter at end of Internal Thread E		Depth of Thread (Max.)	
	inch	mm		inch	mm	inch	mm	inch	mm	inch	mm	inch	mm
1/2"	0.840	21.34	14.0	0.320	4.48	0.5337	7.47	0.7815	10.94	0.77843	19.772	0.05714	1.451
3/4"	1.050	26.67	14.0	0.339	4.75	0.5457	7.64	0.7935	11.11	0.98887	25.117	0.05714	1.451
1"	1.315	33.40	11.5	0.400	4.60	0.6828	7.85	0.9845	11.32	1.23863	31.461	0.06957	1.767
1-1/4"	1.660	42.16	11.5	0.420	4.83	0.7068	8.13	1.0085	11.60	1.58338	40.218	0.06957	1.767
1-1/2"	1.900	48.26	11.5	0.402	4.83	0.7235	8.32	1.0252	11.79	1.82234	46.287	0.06957	1.767
2"	2.375	60.33	11.5	0.436	5.01	0.7565	8.70	1.0582	12.17	2.29627	58.325	0.06957	1.767
2-1/2"	2.875	73.03	8.0	0.682	5.46	1.1375	9.10	1.5712	12.57	2.76215	70.159	0.10000	2.540
3"	3.500	88.90	8.0	0.766	6.13	1.2000	9.60	1.6337	13.07	3.38850	86.068	0.10000	2.540
4"	4.500	114.30	8.0	0.844	6.75	1.3000	10.40	1.7337	13.87	4.38712	111.433	0.10000	2.540

3 Rules and Guidelines

3 Flange Connection

A. Selection of Materials

ESLON Gasket must be resistant to chemicals flowing through the line.

Fasteners-bolts, nuts, and washers, also resistant to the chemical environment. (Threads should be well lubricated.)

Torque Wrench-a necessity for tightening bolts in a manner that guards against excessive torque.

B. Flange Assembly

1. Join the flange to the pipe as outlined in the solvent cementing section or in the threading section depending on the joining method desired.
2. Align the flanges and gasket by inserting all of the bolts through the matching bolt holes. Proper mating of flanges and gaskets is very important for a positive seal.
3. Using a torque wrench, tighten each bolt in

a gradual sequence as outlined by the flange sketch. For final tightening of all bolts, find the recommended torque value in the chart below.

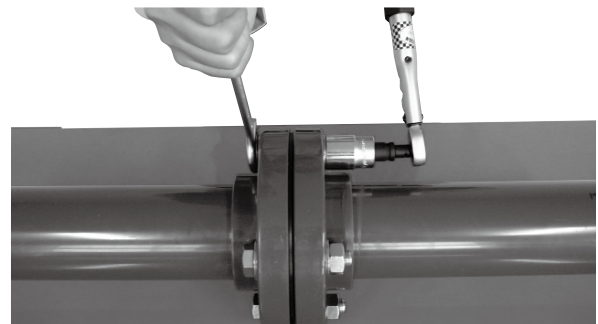
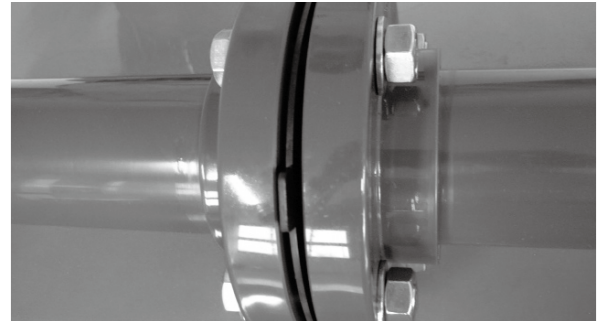

CAUTION

1. Do not over-torque flange bolts.
2. Use the proper bolt tightening sequence.
3. Make sure the system is in proper alignment.
4. Flanges should not be used to draw piping assemblies together.
5. Flat washers must be used under every nut and bolt head.

Recommended Torque

Pipe Size (IPS)	No. Bolt Holes	Bolt Diameter	Approx. Bolt Length* in.	Recommended Torque ft./lbs.
1/2	4	1/2	2 1/2	10-15
3/4	4	1/2	2 1/2	10-15
1	4	1/2	2 1/2	10-15
1 1/4	4	1/2	3	10-15
1 1/2	4	1/2	3	10-15
2	4	5/8	3 1/2	20-30
2 1/2	4	5/8	3	20-30
3	4	5/8	3 1/2	20-30
4	8	5/8	4	20-30
6	8	3/4	4	33-50
8	8	7/8	5	33-50
10	12	7/8	5	53-75
12	12	7/8	5	53-75

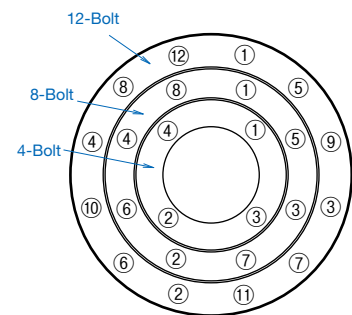

Bolt lengths were calculated using two Eaton flanges. Additional accessories or different mating surfaces will alter these numbers

NOTE: Flange bolt hole pattern meets ANSI B16.5

4

Safety Precautions

Safety Precautions

PVC and CPVC plastic piping systems will give excellent, maintenance-free performance over many years use, as long as the application and system design is correct and installation is properly done. It is most important to know the physical properties and limitations of PVC and CPVC plastic pipe when selecting these materials for an application and when designing the system. In every case, carefully read and follow installation procedures. It is very important to know the reputation and abilities of your installation crew or contractor. Professional engineering design of the system and close supervision of the assembly-installation procedures are highly recommended. Any questions concerning the application or installation of PVC and CPVC piping products should be directed to the supplier, manufacturer or consultant.

WARNING

Failure to follow the safety precautions below may result in misapplication or improper installation and testing which can cause severe personal injury and/or property damage.

General

1. Protect plastic pipe from contact with hard and pointed objects

Impact resistance is lower than for metals.

2. Avoid bending pipe

Pipe should not be bent in trenches or in above ground installations. Pipe and joints that are stressed reduce pressure rating and can cause failures.

3. Protect pipe from extreme heat and cold.

Extremes of heat and cold can cause failure. Allowing liquids to freeze inside PVC/CPVC and metallic piping can cause the pipe and/or the joints to crack. Freeze protection should be de-

signed into the system. Heat beyond design limits can also cause failures.

4. Protect pipe from sunlight.

PVC and CPVC pipe compounds normally do not provide extended protection from the ultraviolet rays of the sun. Therefore, unless the material has been specially formulated to provide protection, the product must be protected from sunlight or some damage may occur after years of exposure.

Application

1. NEVER use PVC and CPVC piping materials to transport compressed air or gases.

Compressed air or gases can surge to high pressures and cause explosive failures that could seriously injure personnel. PVC and CPVC pipe and fittings are excellent products in transporting water and corrosive chemicals.

2. Only use approved chemicals.

Certain chemicals, especially petroleum distillates and derivatives, can cause failure. Every chemical should be verified and approved in the manufacturer's chemical resistance chart.

System Design

1. Allow for flexibility in the design of the system.

Expansion and contraction is greater than for metals. This can cause breaks and leaking points if system design is not flexible to allow for movement. When laying smaller diameters of pipe below ground, the pipe should be "snaked" in the trench to allow for expansion and contraction. If solvent cement welding is used for the method of joining, snaking, pressure testing, and pipe movement should not be done until after the joints have been given sufficient time to dry.

2. Design safeguards into the system to prevent excessive surge pressures.

Water hammer (surge) in a PVC and CPVC system can cause pipe, fittings, and valves to burst. Liquid velocities should not exceed five feet per second maximum.

Installation

1. Carefully follow solvent cement welding instructions.

Failure to correctly follow application procedures can reduce the strength and integrity of joints and cause joint failures. By far, the majority of failures in PVC and CPVC systems are the result of shortcuts and/or improper joining techniques.

2. Remove rocks and other debris that can rupture pipe when burying pipe in trenches.

When laying PVC and CPVC pipe below the ground, care should be taken to remove all rocks, boards, empty primer and cement cans, brushes, bottles and other debris from the trench. Backfilling and top loading should be watched very carefully.

3. Follow recommended support spacing for PVC and CPVC piping systems.

The modulus of elasticity of PVC and CPVC pipe is smaller than metals. Maximum working temperature and room temperature should be considered when determining the required support spacing.

Testing

1. NEVER use compressed air or gas or air-over-water boosters to pressure test PVC or CPVC piping systems.

ONLY hydrostatic pressure testing is to be conducted on PVC and CPVC piping systems. Com-

pressed air or gases can surge to high pressures and cause explosive failures that could seriously injure personnel.

2. Carefully follow all instructions for hydrostatic pressure testing.

Failure to follow these instructions can result in a system failure.

3. Before water-testing a system, always bleed all entrapped air from system.

Entrapped air is a major cause of surge and burst failure in plastic piping systems.

SEKISUI CHEMICAL CO.,LTD.

Industrial Piping System Division 2-3-17 Toranomon Minatoku,Tokyo,105-8450 Japan
TEL +81-3-5521-0555 FAX +81-3-5521-0753

<http://www.eslon-plant.jp> E-mail: eslon_valve@sekisui.jp

SEKISUI INDUSTRIAL PIPING CO., LTD.

No.18, Jing 1st Rd.,Chung Kang Export Processing Zone, Wuqi Dist., Taichung City 43541, Taiwan, R.O.C.
TEL +886-4-2657-3688 FAX +886-4-2657-9638

SEKISUI (HONG KONG) LTD.

8th Floor, 111 Leighton Road, Causeway Bay, Hong Kong
TEL +852-2890-9161 FAX +852-2577-1908

SEKISUI (SHANGHAI) INTERNATIONAL TRADING CO., LTD.

Room 702-707, Metro Tower, No.30, Tianyaoqiao Road Shanghai. 200030, China
TEL +86-21-6482-0638 FAX +86-21-6482-0639

SEKISUI CHEMICAL SINGAPORE (PTE.) LTD.

2 Jurong East Street Road 21,#05-17,IMM Building,Singapore 609601
TEL +65-6562-5081 FAX +65-6562-5021

SEKISUI CHEMICAL G.m.b.H.

Cantadorstr.3 40211 Dusseldorf, Germany
TEL +49-211-36977-0 FAX +49-211-36977-31

Copyright 2008
SEKISUI CHEMICAL CO., LTD.
May not be copied in whole or part.
Revision No.1, Jan. 2008

Printed October.2012.2nd Edition
ESLON
SCH80 PVC & CPVC Piping Systems
Specifications & Engineering Manual
SEKISUI CHEMICAL CO.,LTD.
Industrial Piping System Division

No. 06270

2012. 10. 5TH TX